

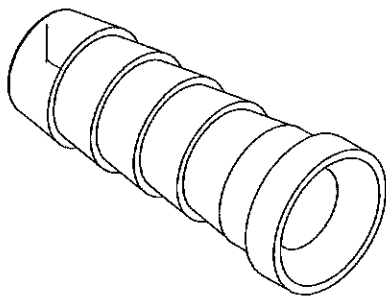

LINE DRAWING NOT FOR PRODUCTION PURPOSES

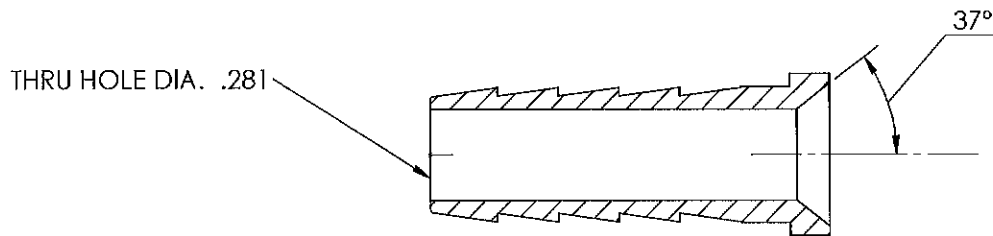
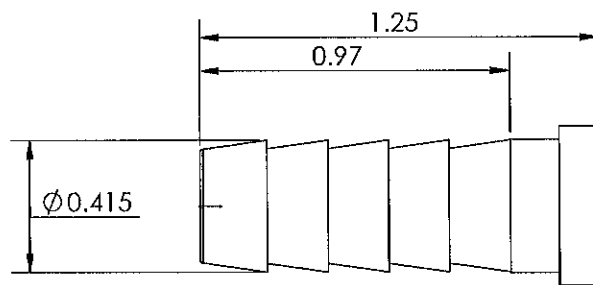

THIS DRAWING CONTAINS INFORMATION DEEMED PROPRIETARY TO DIXON BRASS AND IS SO TO BE USED ONLY FOR THE PURPOSE FOR WHICH IT IS SUBMITTED, AND FURTHER, SHALL NOT BE COPIED IN WHOLE OR IN PART WITHOUT EXPRESS WRITTEN PERMISSION FIRST OBTAINED FROM DIXON BRASS.			
UNLESS OTHERWISE SPECIFIED:		DRAWN P. MONAGHAN	
DIMENSIONS ARE IN INCHES		DATE 6/13/14	
TOLERANCES: ANGLE: ±0°30' .X (±.015) .XX (±.010) .XXX (±.005)		APPROVED DATE	
DIMENSIONS PER ANSI Y14.6		ECO NO.	
 Dixon Brass Westmont, Illinois USA		DRAWING NOT REPRODUCED TO SCALE	
TITLE: FEMALE SWIVEL STEM 37 DEG. JIC SEAT		SIZE A	DWG. NO. 1450609S
			REV C

LINE DRAWING NOT FOR PRODUCTION PURPOSES

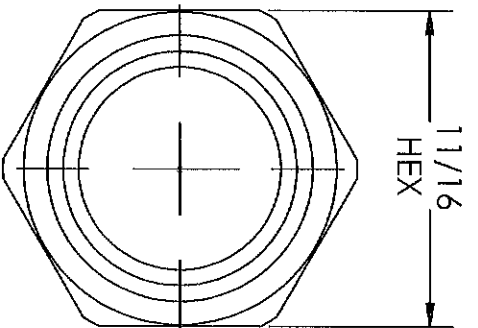
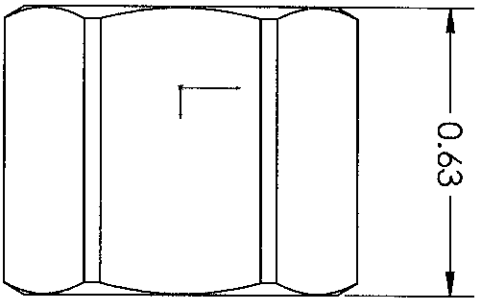

9/16-18 UNF-2B

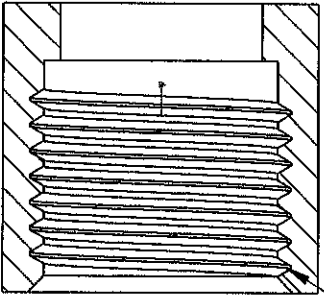

This drawing is owned by Dixon Valve & Coupling Co. and shall be returned upon demand. It is loaned on condition that it shall not be copied or reproduced or submitted to others without the owners consent. In accepting it, subject to this condition, the recipient further agrees that this drawing or any design detail or concept disclosed herein shall not be used in any way detrimental to or in competition with the owner. If the recipient does not agree to the terms of this agreement they shall return this drawing immediately. The information contained in this drawing is subject to change without notice.

 <p>The Right Connection</p>	<p>Dixon Brass Westmont, Illinois USA</p>	<p>DATE</p>
		<p>11/10/14</p>
<p>TITLE:</p>	<p>WELDING NUT (OXYGEN)</p>	<p>DATE</p>
<p>DO NOT SCALE THIS DRAWING</p>	<p>DATE</p>	<p>DATE</p>
<p>SIZE</p>	<p>DWG. NO.</p>	<p>REV</p>
<p>A</p>	<p>1520309N</p>	<p>E</p>